







910-10-1045







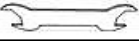
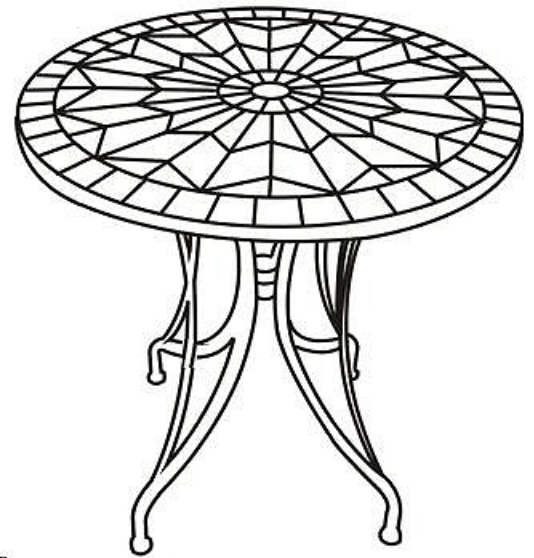
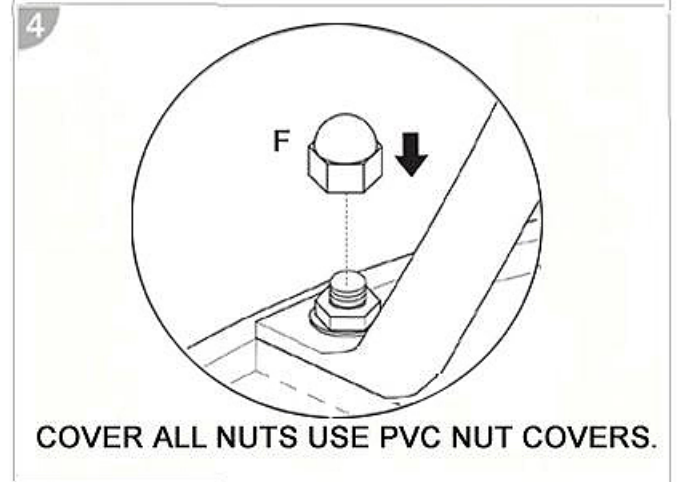
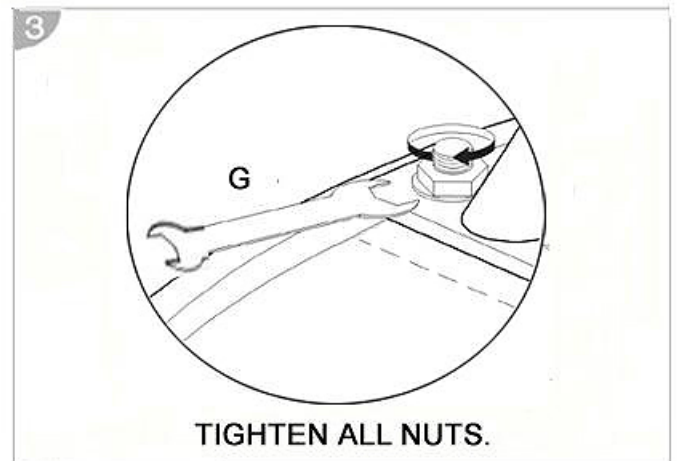
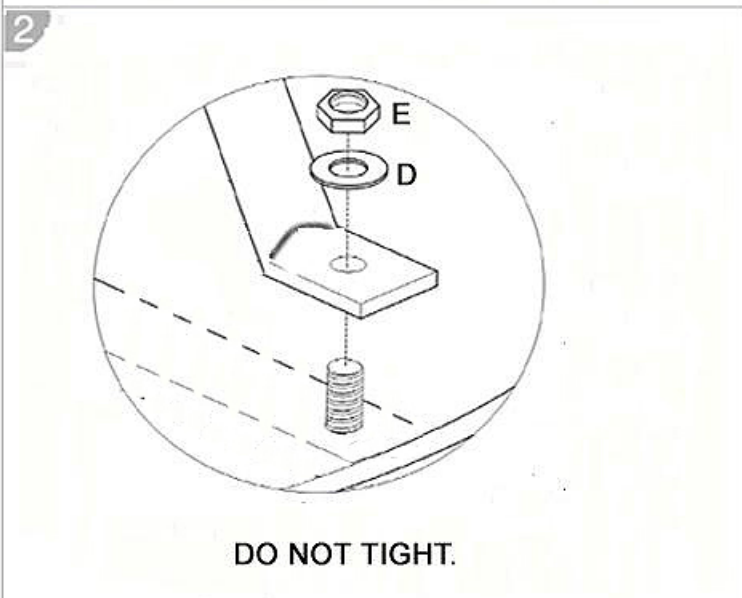
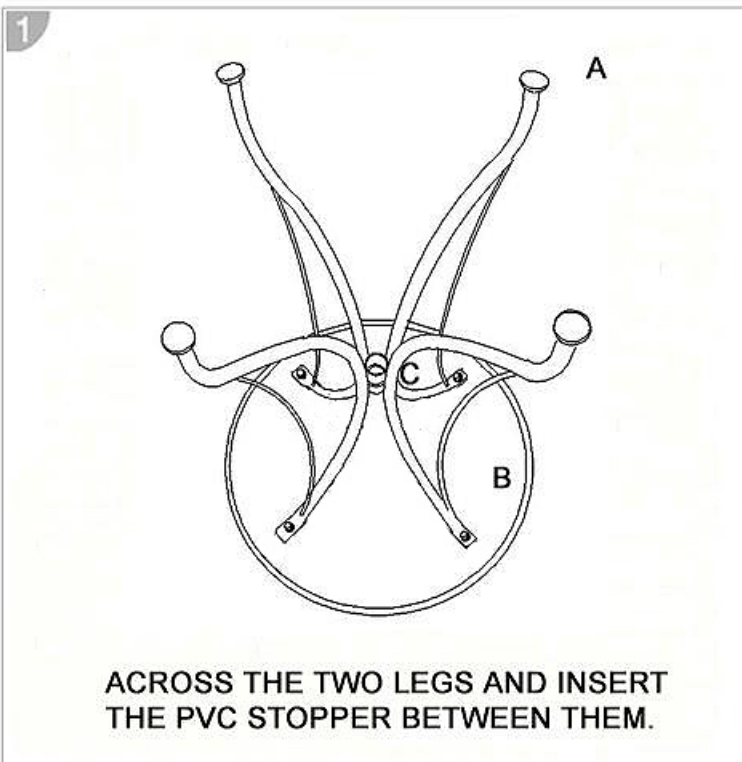

Item	Name	Description	Qty
A	Leg (1)		1
	Leg (2)		1
B	Table top		1
C	PVC Stopper		1
D	Washer		4
E	Nut		4
F	PVC Nut Cover		4
G	Spanner		1



Please read the assembly instruction carefully before assembling.



910-10-1045

Article	Nom	Description	Qté
A	Patte (1)		1
	Patte (2)		1
B	Haut de table		1
C	Arrêt de PVC		1
D	Rondelle		4
E	Écrou		4
F	Écrou à chapeau de PVC		4
G	Clé		1



Veuillez soigneusement lire les instructions de montage avant l'assemblage.

