

SUZANO
902-14-1010

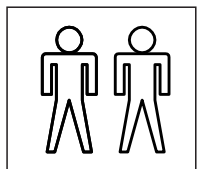

Ⓐ x1

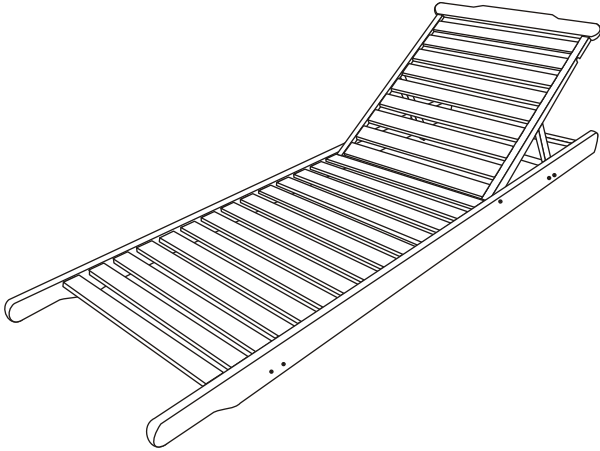

Ⓑ x1

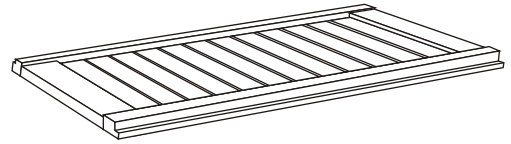

Ⓒ x1

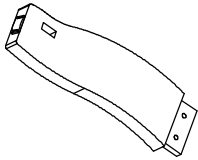

Ⓓ x1

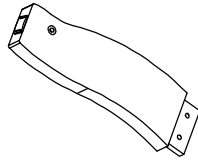

Ⓔ x2

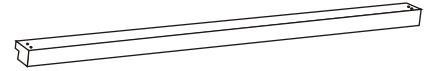

Ⓕ x2

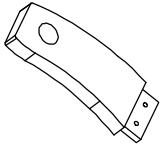

Ⓖ x2

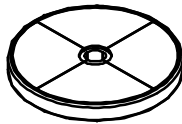



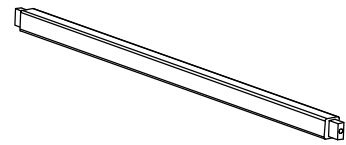

Ⓗ x1

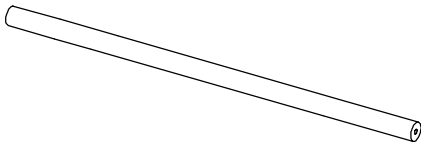

Ⓘ x1

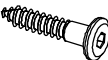
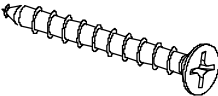
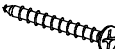

Ⓐ		(7x20)	8	Ⓔ		(8x40x3)	2
Ⓑ		(7x40)	4	Ⓘ		(4x40)	2
Ⓒ		(4x30)	8	Ⓙ		(4x98)	2
Ⓓ		(26x50x2)	2				

1 / 2

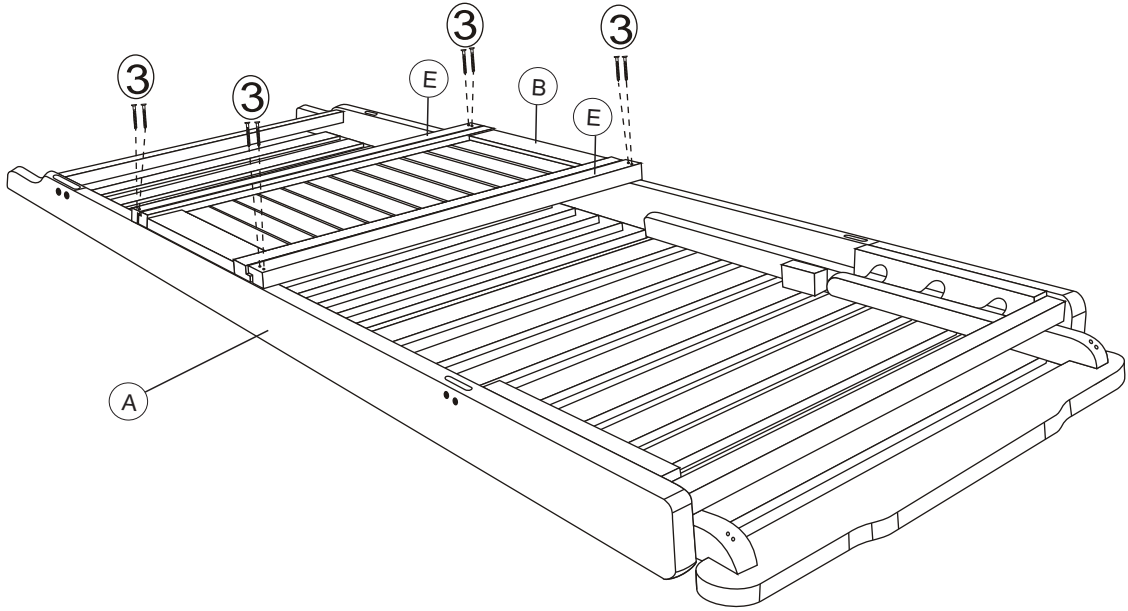

2 / 2

